

Praise on the Prairie

*Volume 12 • Issue
9
September, 2020*

ST. PETER'S LUTHERAN CHURCH & SCHOOL

Church: 888-2250 -- School: 888-2252

E-MAIL: splcasop@madisontelco.com

Prairietown, Illinois

Rev. Brandon Larson, Pastor Melissa Burns, Principal

Youth & Adult Bible Class 9 a.m.

Sunday School, 9 a.m.

*Worship, 10:00 a.m. Sundays and 5:30 p.m. the 2nd & 4th Saturdays of the
month*

Dear friends in Christ,

August has brought the beginning of a new school year and a new season at St. Peter's. A couple weeks back, we modified our schedule to get just a little bit closer to normal (whatever that means). So far things have been going very well despite living with this pandemic that has brought so many changes to the world around us. I hope and pray that you're staying healthy and sane during this time. I also wanted to thank you for all the birthday wishes this past week. Even though we've only been here for about 6 months, you have all made us feel like family.

In the next couple of weeks, I'm going to be getting information out to parents for the beginning of Confirmation instruction for public school students. If you're the parent of a 7th or 8th grader, would you please reach out to me so I can make sure you're included? We also plan on holding a new member's class in either September or October, so if you're interested in becoming a member of St. Peter's, please let me know.

As this pandemic drags along, there is always a risk of getting overwhelmed and discouraged. I know some of you are feeling it, and I know many of my brothers in the Office of the Holy Ministry often feel it too. So I'll leave you with the words of St. Paul from Galatians, "And let us not grow weary of doing good, for in due season we will reap, if we do not give up." (6:9).

Your partner in the Gospel,
+ Pastor Brandon Larson +

Preparing for Worship

Sept. 5 Worship outside/communion
Sat. Communion: Erin Goebel, Leona
6 p.m. Goebel

Sept. 6 14th Sun. after Pentecost/communion
Sun. Organist: Donna Kinder
8 a.m. Elder of the week: John Wiemers

Sept. 11 Worship outside
Sat.
6 p.m.

Sept. 13 15th Sun. after Pentecost/communion
Sun. Organist: Jim Wiemers
10 a.m. Communion: Michelle Goebel
Elder of the week: Don Wiemers

Sept. 19 Worship outside
Sat.
6 p.m.

Sept. 20 16th Sun. after Pentecost/communion
Sun. Organist: Deagan Jones
10 a.m. Communion: Sue Goebel, Brenda
Gusewelle
Elder of the week: Rich Jones

Sept. 26 Worship outside
Sat.
6 p.m.

Sept. 27 17th Sun. after Pentecost/communion
Sun. Organist: Jim Wiemers
10 a.m. Communion: Emily Gusewelle
Elder of the week: Charles Tedrick



Banners: Linda Wiemers
Flowers: Connie Schaefer
Ushers: Aaron Kuethe, Adam Kuethe,
Glenn Meyer, Babe Edsall



*Thank You
Notes*

Thank you for the cards, well wishes, and prayers offered during the past few months. Special Thank You to Missy Burns, Connie Schaefer and Terri Scheumann for the rides to radiologist and the delicious meals. I know God is with me during this journey and I'm truly thankful for the support of my St Peters family. Gods Blessings to you all!

Stephanie Schaefer

Thank you to everyone who has been cutting crosses for the prison ministry. Unfortunately we have not been able to get in for our weekly Bible Studies, so we are not in need of them. Thankyou again to everyone who has helped.

Linda Tedrick

BUDGET REPORT

OPERATING BUDGET 2020	\$ 291,244
AMOUNT NEEDED	5,600

OUR CHALLENGE THRU AUG. 23	\$ 190,400
OUR RESPONSE THRU AUG. 23	182,005
SHORT	8,395

MISSION

2020 BUDGET	\$ 5,000
WEEKLY AMOUNT NEEDED	96

OUR CHALLENGE THRU AUG. 23	\$ 3,264
OUR RESPONSE THRU AUG. 23	3,117
SHORT	\$ 147

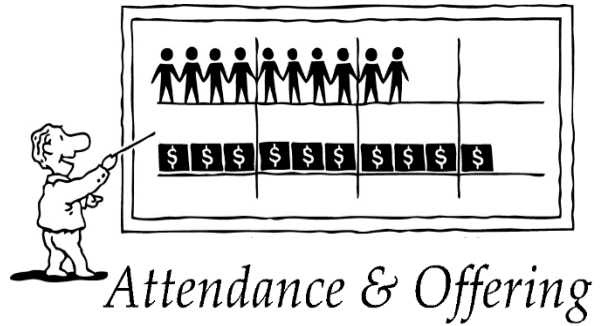

August Attendance

	Divine Service/ Lord's Supper
August 2	72
August 8	50
August 9	42
August 15	46
August 16	64
August 22	33
August 23	40

August Financial Report

	HOME	MISSION FUND	BUILDING	DEBT	TUITION	METRO EAST
August 2	\$3,765.00	\$ 170.00	\$ 443.00		\$2,540.00	
August 8 & 9	\$4,670.36	\$ 10.00	\$ 125.00		\$5,148.34	
August 15 & 16	\$4,174.00	\$ 15.00			\$1,250.00	
August 22 & 23	\$3,125.00	\$ 10.00	\$ 135.00		\$1,262.50	\$ 100.00



SPECIAL INTERCESSIONS

Recovering at home: Riley Dempsey

Dealing with Cancer: Jerry Werner, Stephanie Schaefer, Donna Scherff

Care facilities or homebound: David Kinder, Murray Center, Centralia; Marian Isenberg in Holly Brook, East Alton, JoAnn Lesemann in Villa Rose; Robert Werner in Glenwood; Charlotte Werner in Heritage Manor; Maurice Duncan at home; Frances Westerhold in Glenwood; Wilma Braasch in Glenwood

Ongoing Health Issues: Gloria Hacking, Rocky Lane, Diane Oberkfell, Ben Goebel, David Peters, Aaron Peters; Denise Horton; John Dinnius

All serving in the Armed Services: Jeff Eden, Todd Oberkfell, Kaleb Beeler (grandson of Jerry & Pat Bock)

NEWS AND ANNOUNCEMENTS

CHURCH STATISTICS

JOINED THE CHURCH

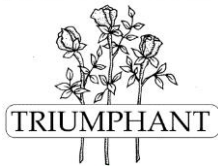

8-11-20 Steven Lesemann



8-29-20 Wrenley Thornton
Daughter of Tyler & Lindsey (Goebel)
Thornton

PASTOR LARSON'S phone number is 928-542-1902. His e-mail address is B_Larson @me.com.

CHURCH HOURS: 6 pm Outdoor Service every Saturday. Communion on **first Saturday** of the month.

9 am Bible Class every **Sunday** in the sanctuary.
10 am Service in the Sanctuary every **Sunday**,
Communion 2nd, 3rd, 4th, & 5th Sundays of the month.

SUNDAY SCHOOL classes will begin on September 6 at 9 am. Nursery thru 2nd grade will meet in the classroom in the annex and the 3rd through 8th in the school. Students will be sitting 6' apart. We are looking for volunteers who would be willing to teach part-time. If interested, contact Norma Krohne at 888-2256 or 888-2250.

HUMAN CARE for September will be for LWR. We will be collecting health kit supplies. Items needed are bars of soap, single packaged toothbrush, large sturdy combs, large dark colored towel (between 20 x 40 & 52 x 27). Items can be brought to the church every morning from 8:30 am to 11:30 am or on Sunday morning. Boxes will be shipped in October.

METRO-EAST LUTHERAN HIGH SCHOOL is looking for a part-time Maintenance/Handyman to work at our High School campus. The position is approximately 20 hours per week and the hours and days/times can be very flexible. If you are interested please contact Dr. Jay

Krause, Principal at 618-656-0043 or email him at jay.krause@melhs.org.

TIME FOR A POP QUIZ!

Tests don't end once you finish school. Churchgoers of all ages can regularly conduct these quick assessments:

- The worship test: Do I faithfully attend worship services and Bible studies?
- The weather test: Am I a "fair weather" Christian? Do conditions that wouldn't keep me from work keep me from church?
- The work test: Am I willing to put my talents to use for my church? Can the congregation count on me to help however possible, or am I too busy elsewhere?
- The wallet test: Do I regularly contribute or tithe? Am I giving my "first fruits" to God so the church can conduct his work?

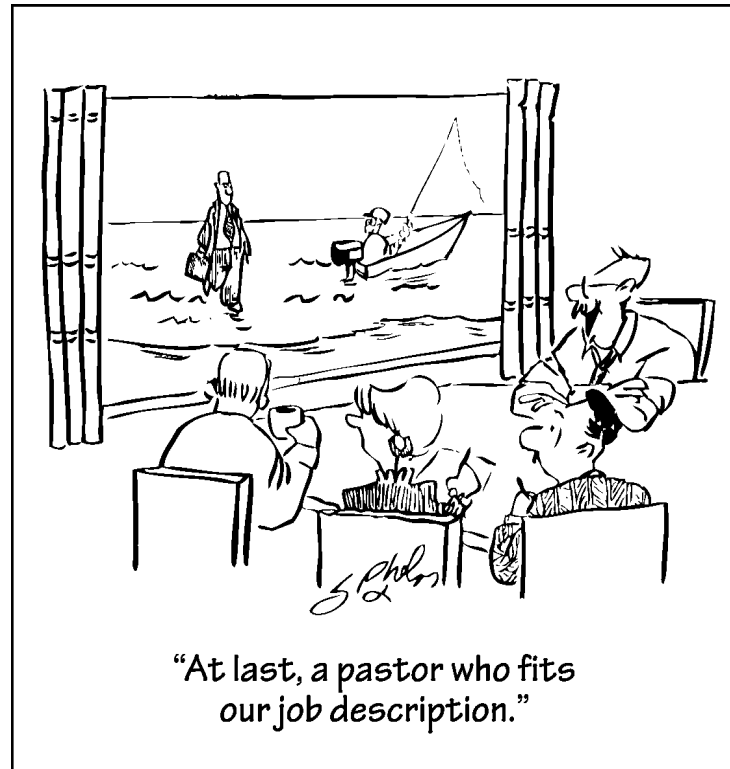

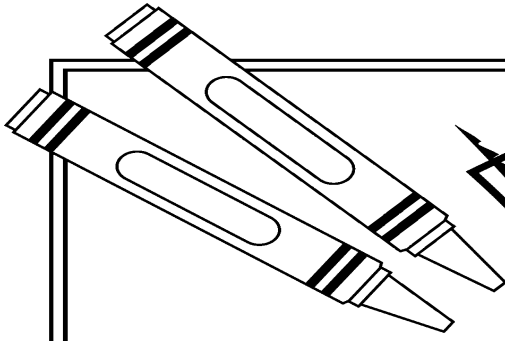

PUZZLE

IT'S A MIRACLE!

Jesus performed many amazing miracles during his earthly ministry.

Directions: Match the words and pictures of different healings, from one column to the other. Then fit the word pairs in the blanks below to complete Matthew 11:5, NIV.



blind



leprosy



lame



deaf

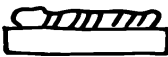

dead



hear



walk



raised

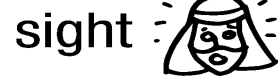

sight

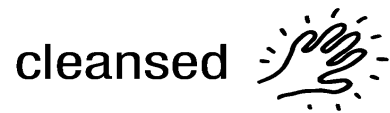

cleansed

The _____ receive _____, the _____, those
who have _____ are _____, the _____
_____, the _____ are _____

MATTHEW 11:5, NIV

Answer: The blind receive sight, the lame walk, those who have leprosy are cleansed, the deaf hear, the dead are raised Matthew 11:5, NIV

September 2020

Sunday	Monday	Tuesday	Wednesday	Thursday	Friday	Saturday
		1	2 8:30 AM Chapel	3	4	5 6:00 PM Worship w/communion outside
6 Elder of the week John Wiemers 9:00 AM Youth & Adult Bible Study 10:00 AM Worship inside	7 No School	8	9 8:30 AM Chapel	10	11	12 6:00 PM Worship outside
13 Elder of the week Don Wiemers 9:00 AM Youth & Adult Bible Study 10:00 AM Worship w/communion inside	14	15	16 8:30 AM Chapel	17	18	19 6:00 PM Worship outside
20 Elder of the week Rich Jones 9:00 AM Youth & Adult Bible Study 10:00 AM Worship w/communion inside	21	22 Autumn begins	23 8:30 AM Chapel	24	25	26 6:00 PM Worship outside
27 Elder of the week Charles Tedrick 9:00 AM Youth & Adult Bible Study 10:00 AM Worship w/communion inside	28	29 7:30 PM Elder's Meeting	30 8:30 AM Chapel			

St. Peter's Lutheran Church and School
7183 Renken Road
Dorsey, Il. 62021



September Birthdays

Madelyn Allman, Jenna Harbin	3 rd
Jerry Bock, Evelyn Saunders	7 th
Tony Lebro, Donna Scherff	8 th
Sara Goebel, Diana Peters,	
Lonnie Pruett	9 th
Amy Goebel	10 th
Casey Dinnius, Patrick Thirion	12 th
Courtney Bilyeu, Gerald Schaefer	13 th
Zeke Bettorf	15 th
Josie Hemmer, Jai Kansal	18 th
Judy Haynes	22 nd
Chad Harbin, Jan Toring	23 rd
Andrea Downard,	
Karlie Woszczyński	27 th
Brooke Wiemers	28 th
Janine Meyer, Virginia Singleton	29 th
Denise Horton, Nancy Wiemers	30 th

September Anniversaries

Roger & Beverly Dustmann	42 years on 9/2
Jim & Bonnie Bushrow	34 years on 9/5
Ron & Janet Isenberg	52 years on 9/7
Michael & Stephanie Schaefer	31 years on 9/9
Zeke & Marine Bettorf	23 years on 9/12
Michael & Sue Goebel	40 years on 9/14
John & Emily Gusewelle	14 years on 9/16
Jeff & Sarah Helle	18 years on 9/21
James & Andrea Downard	10 years on 9/24
Tyler & Lindsey Thornton	10 years on 9/25
Rick Schott & Kathy Mielke	9 years on 9/27